

NDP-5 Specifications

Port Dimensions (3.4 GPM Max.)

Intake & discharge connection:	1/4" Female NPT
Air inlet (incl. ball valve):	1/4" Female NPT
Air exhaust (internal silencer):	3/8" Female NPT

Maximum Liquid Temperature

Fitted with PTFE diaphragm

Pump Material	Temperature
Groundable Acetal	180°F (82°C)
Polypropylene	180°F (82°C)
Aluminum	212°F (100°C)
Kynar® (PVDF)	212°F (100°C)
Stainless Steel (316)	212°F (100°C)

Air Supply Pressure (All Models)

20–100 PSI (1.4–7 kgf/cm²)

Discharge Volume Per Cycle

0.0078 gallons (29 cc)

Maximum Cycles Per Minute 400

Maximum Dry Suction Lift 5-ft

Air Motor

Ryton® air motor standard

Valve Type

Flat



Aluminum

Dimensions: 6.1"W x 5.87"H

Net Wt.: 3.3 lbs. (1.5 kg)

Shipping Wt.: 4.3 lbs.

Stainless Steel

Dimensions: 6.14"W x 5.79"H

Net Wt.: 3.7 lbs. (1.67 kg)

Shipping Wt.: 4.7 lbs.

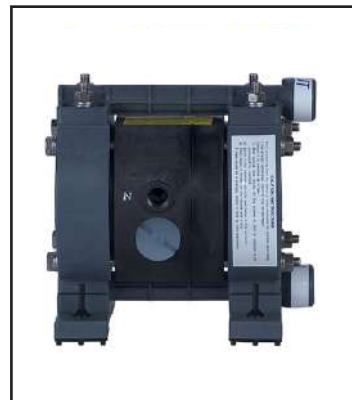

Groundable Acetal

Dimensions: 6.14"W x 5.79"H

Net Wt.: 3.7 lbs. (1.67 kg)

Shipping Wt.: 4.7 lbs.



Polypropylene

Dimensions: 6.14"W x 5.79"H

Net Wt.: 3.0 lbs. (1.36 kg)

Shipping Wt.: 4 lbs.



Kynar®

Dimensions: 6.14"W x 5.79"H

Net Wt.: 3.7 lbs. (1.67 kg)

Shipping Wt.: 4.7 lbs.

Model Number Nomenclature

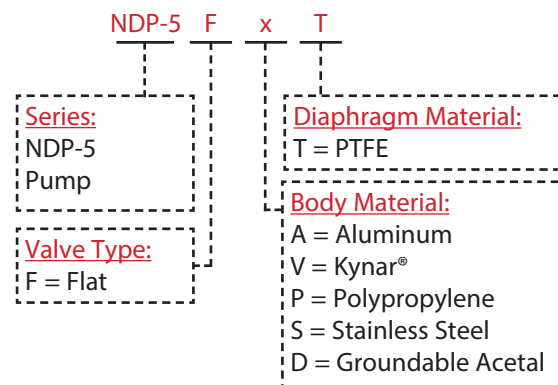

NDP-5 Performance Curve

All Diaphragm Materials

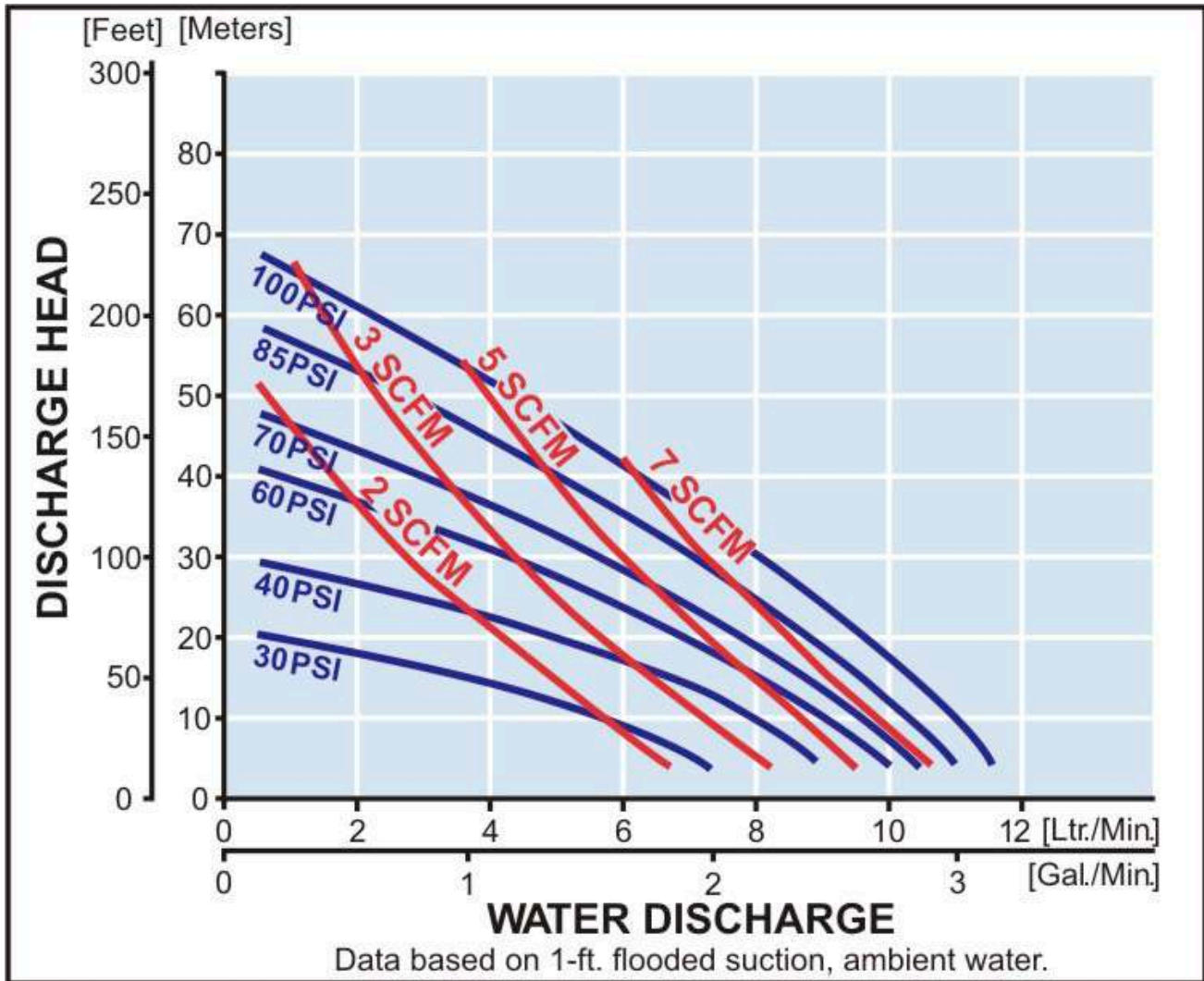

NDP-5 Aluminum

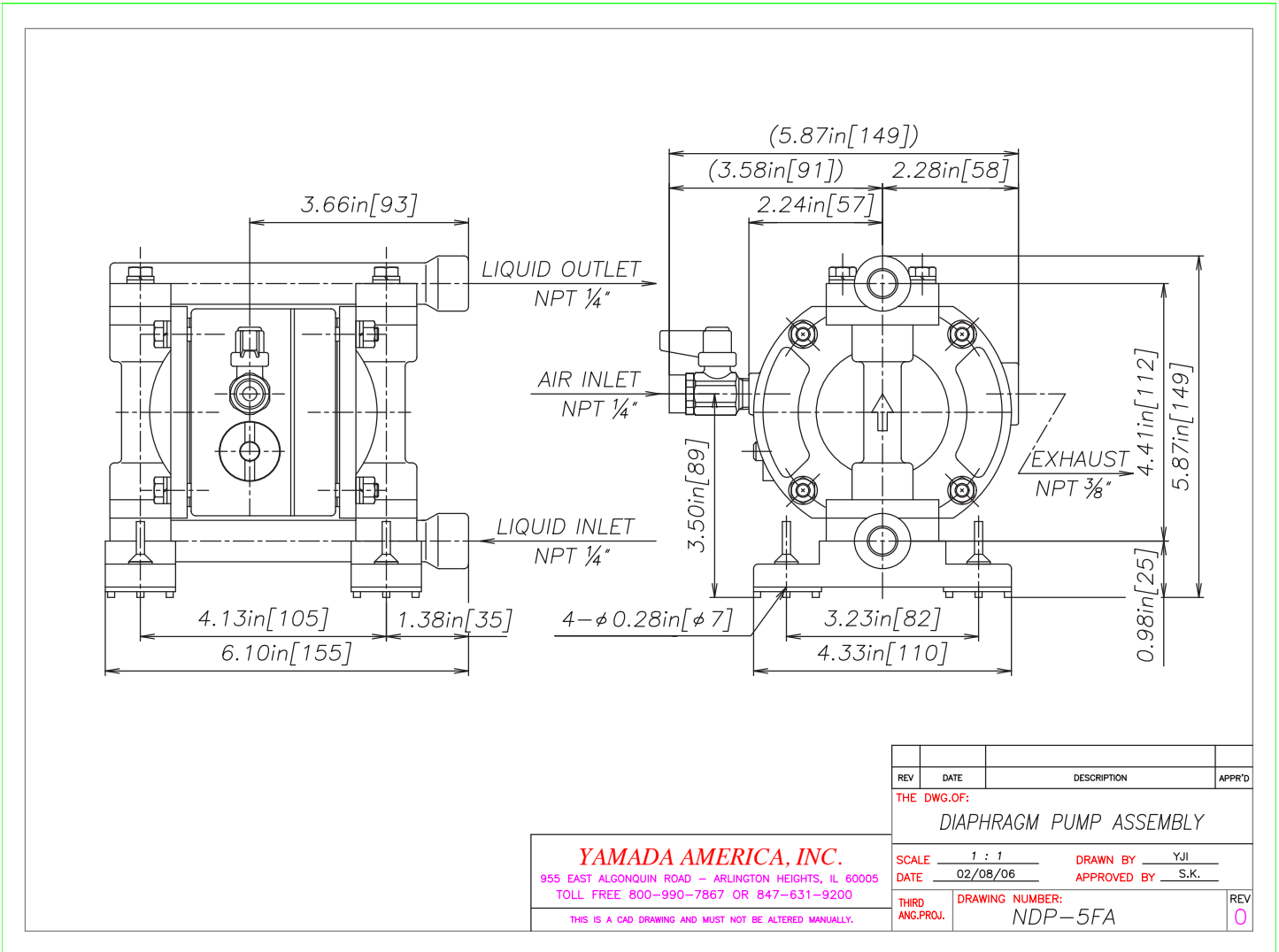

NDP-5 Stainless Steel

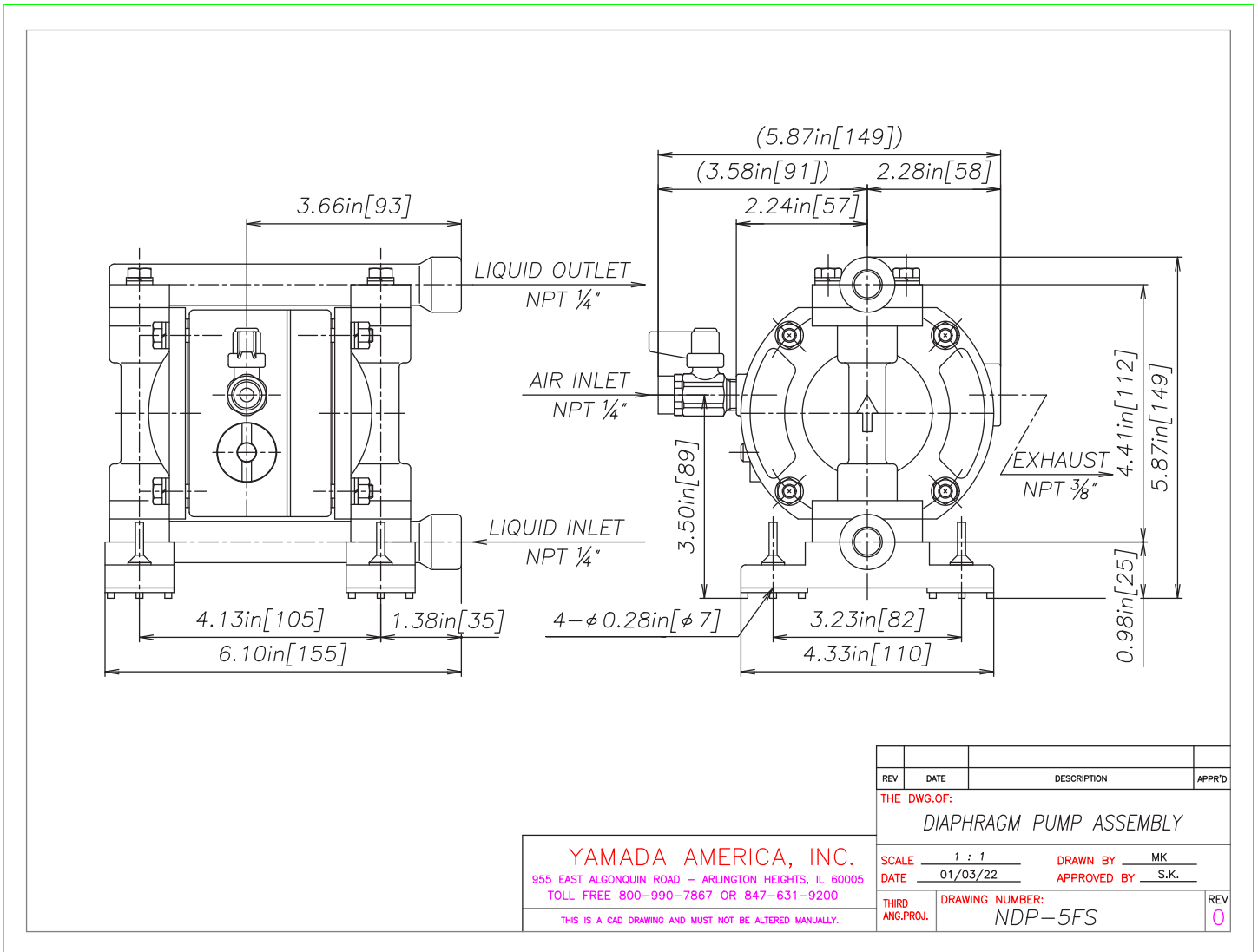

NDP-5 Polypropylene & Groundable Acetal

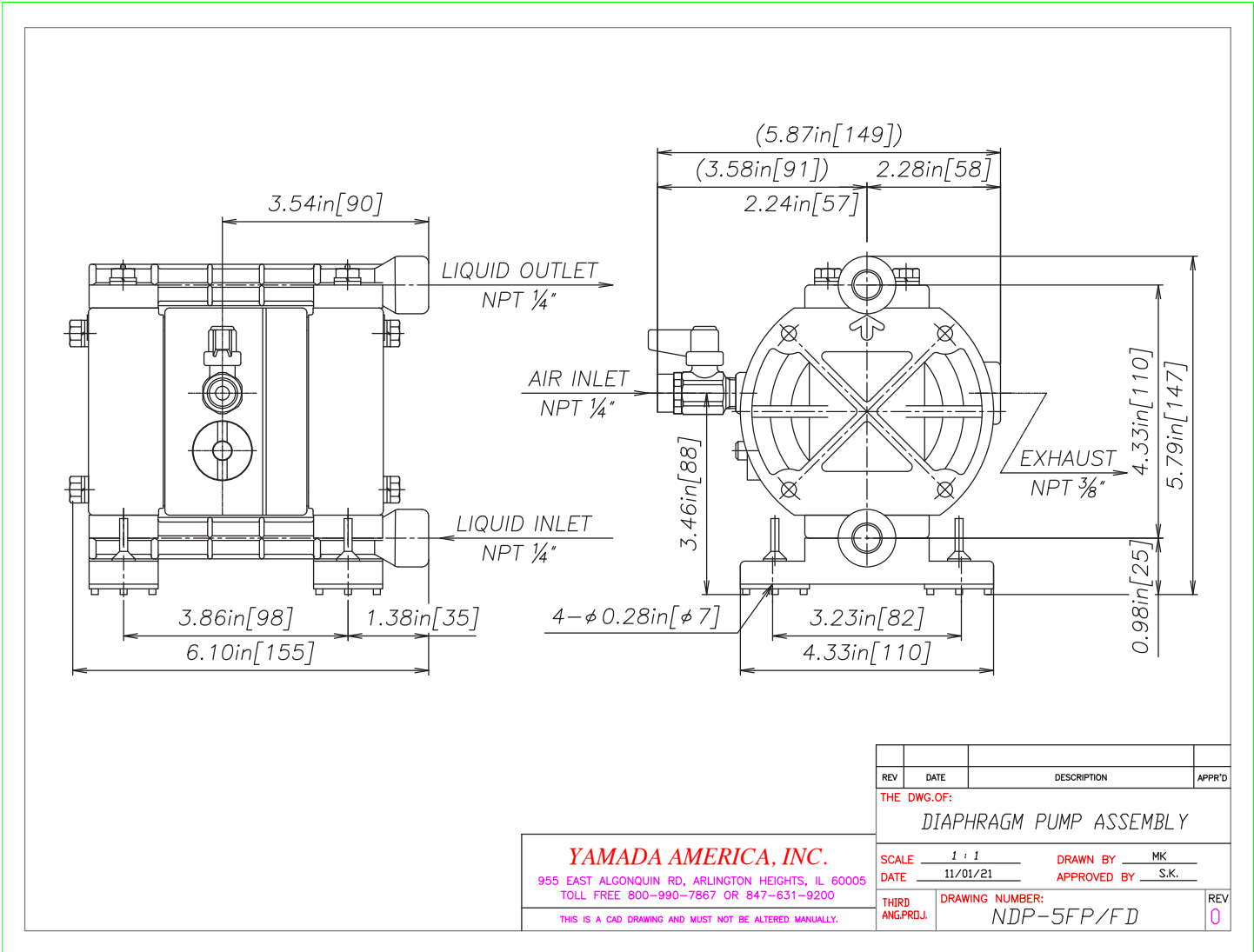

NDP-5 Kynar

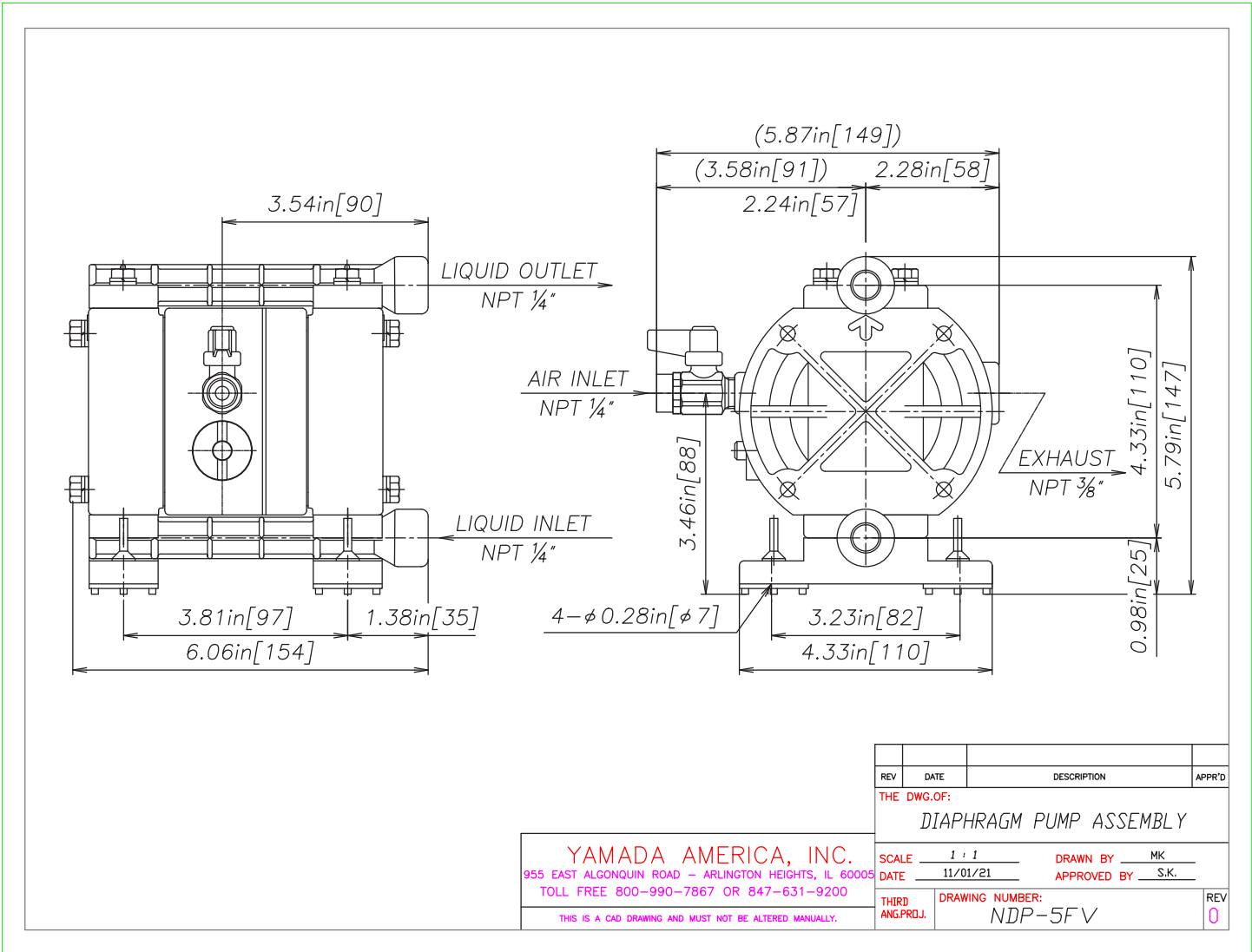

AutoCAD® is a registered trademark of Autodesk, Inc.

Hytrel® is a registered trademark of E.I. du Pont de Nemours and Company.

Kynar® is a registered trademark of Arkema.

Nordel™ is a trademark of DuPont Dow Elastomers.

Ryton® is a registered trademark of Chevron Phillips Chemical Company.

Santoprene® is a registered trademark of Advanced Elastomer Systems.

Viton® is a registered trademark of DuPont Performance Elastomers.

Swagelok™ & VCR™ are trademarks of the Swagelok Companies.

Flaretek® is a registered trademark of Entegris.

Garlock ONE-UP® is a registered trademark of W.L. Gore & Associates.

Yamada® is a registered trademark of Yamada America, Inc.

SolidPRO Designed to Pump Fluids Containing Solids® is a registered trademark of Yamada America, Inc.

Xtreme Duty Pro XDP® is a registered trademark of Yamada America, Inc.

The Proof's in the Pump® is a registered trademark of Yamada America, Inc.

The Proof is in the Pump® is a registered trademark of Yamada America, Inc.

Engineered to Perform. Designed to Outlast.® is a registered trademark of Yamada America, Inc.

Due to Yamada's continued commitment to product improvement, specifications may change without notice.